

Не для продажи!

# КАЛЕНДАРЬ ОЖИДАНИЯ НОВОГО ГОДА

Подготовила Марина Вальс / <https://www.instagram.com/pro.schastye>  
Изображения: freepik.com, depositfotos.com



31  
ДЕНЬ



**САМОЕ ВРЕМЯ НАПИСАТЬ ПИСЬМО ДЕДУ МОРОЗУ!**



**ДОРОГОЙ ДЕДУШКА МОРОЗ!**

**МЕНЯ ЗОВУТ \_\_\_\_\_ МНЕ \_\_\_\_\_ ЛЕТ**

**В ЭТОМ ГОДУ Я ВЕЛ / ВЕЛА СЕБЯ \_\_\_\_\_,**

**И МНЕ БЫ ОЧЕНЬ ХОТЕЛОСЬ ПОЛУЧИТЬ В ПОДАРОК \_\_\_\_\_**

-----  
-----  
-----

**ЗАРАНЕЕ БОЛЬШОЕ ТЕБЕ СПАСИБО!**



**1  
ДЕКАБРЯ**



ЭТОТ ПОЧТОВЫЙ ГОЛУБЬ СОБИРАЕТСЯ ДОСТАВИТЬ ДЕДУШКЕ ТВОЕ ПИСЬМО.  
НАДО ЕМУ ПОМОЧЬ!

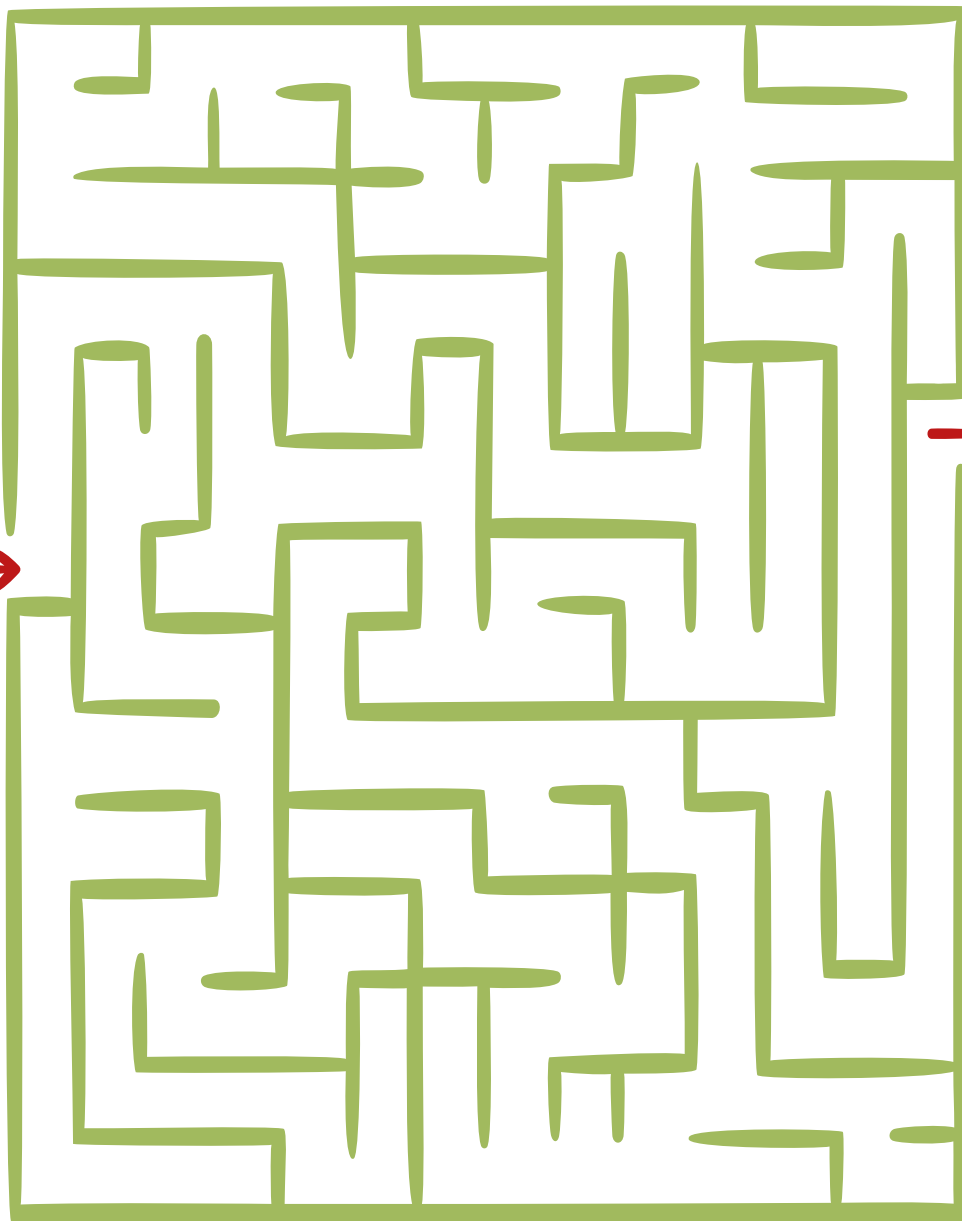

2  
ДЕКАБРЯ



РАСКРАСЬ ЭТУ КАРТИНКУ РАЗНЫМИ ЦВЕТАМИ



# СДЕЛАЙ ПОДЕЛКУ-ЁЛОЧКУ

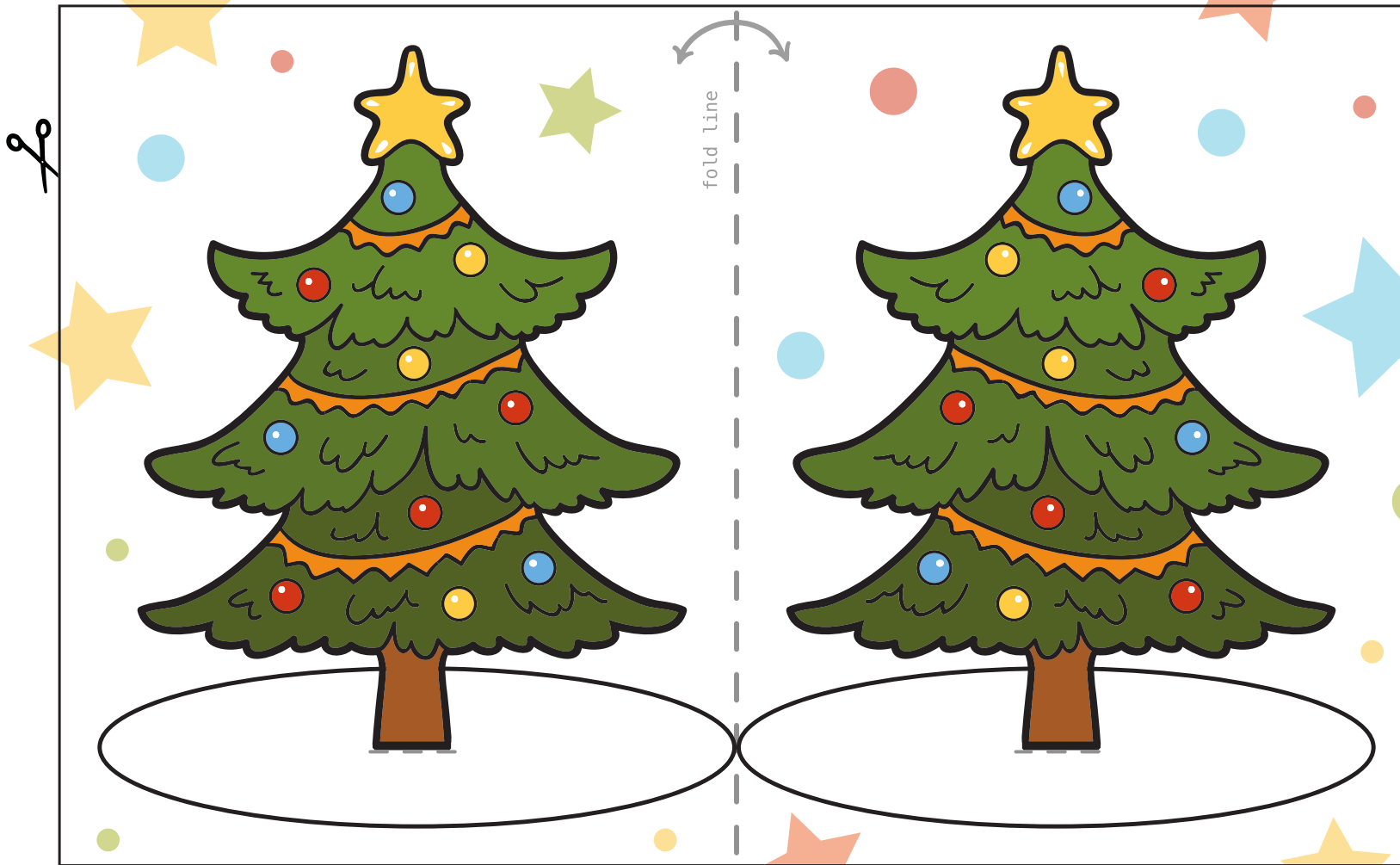

① Вырежи контур



② Сложи и склей



③ Вырежи фигурку



④ Согни и играй



















4  
ДЕКАБРЯ



# СУДОКУ: ВЫРЕЖИ НЕДОСТАЮЩИЕ ФИГУРКИ И ПРИКЛЕЙ НА НУЖНЫЕ МЕСТА

ТАК, ЧТОБЫ В КАЖДОЙ СТРОКЕ И В КАЖДОМ СТОЛБЦЕ ВСЕ ЧЕЛОВЕЧКИ БЫЛИ РАЗНЫМИ.



НАЙДИ 10 ОТЛИЧИЙ



ОТВЕТ:

6  
ДЕКАБРЯ



# РАСКРАСЬ ПО НОМЕРАМ

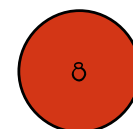
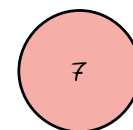
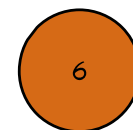
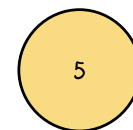
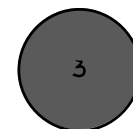
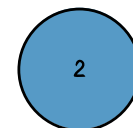
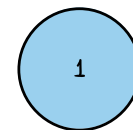
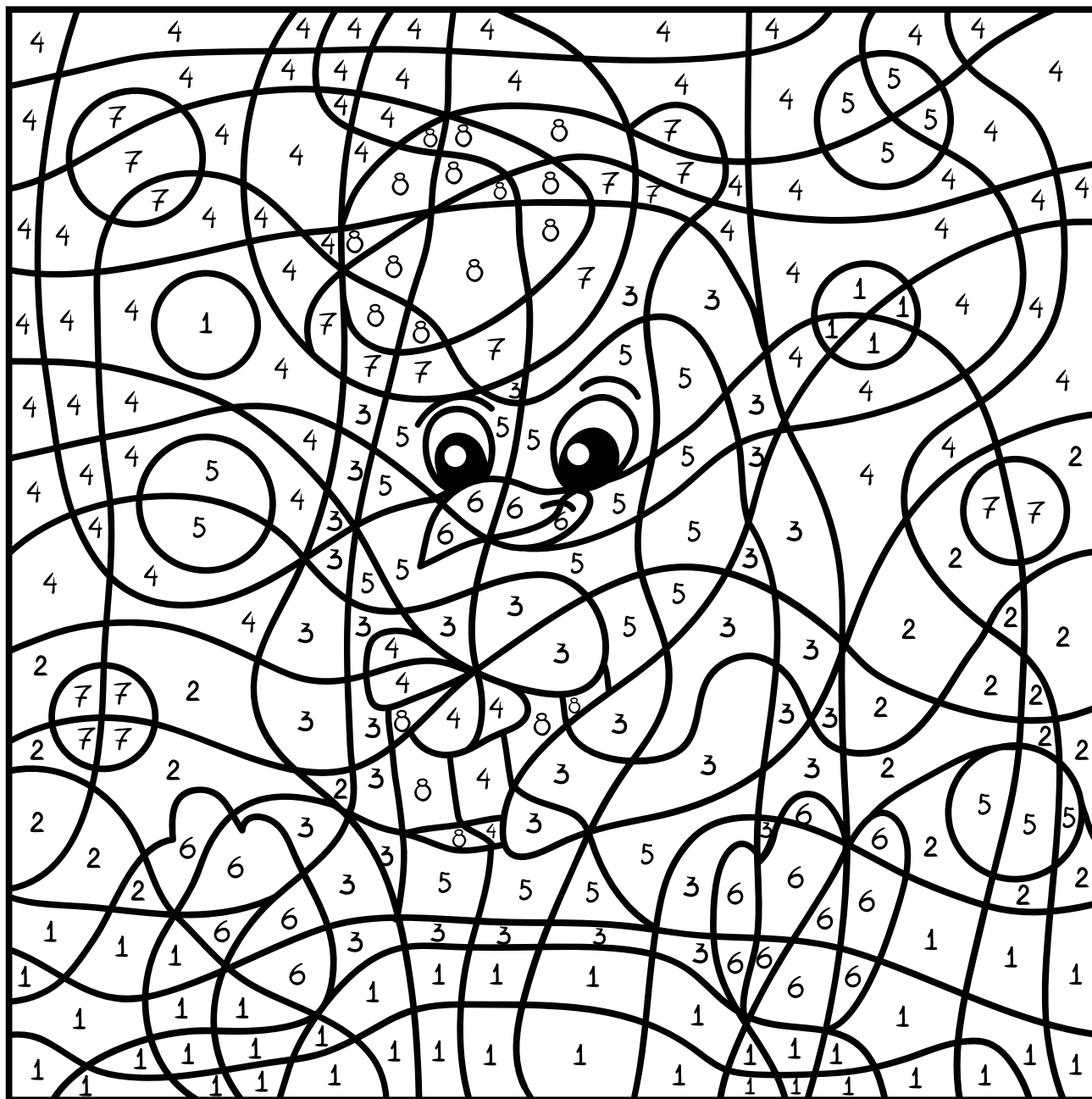



СДЕЛАЙ АППЛИКАЦИЮ

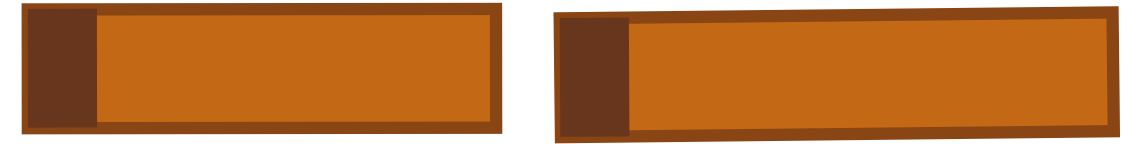
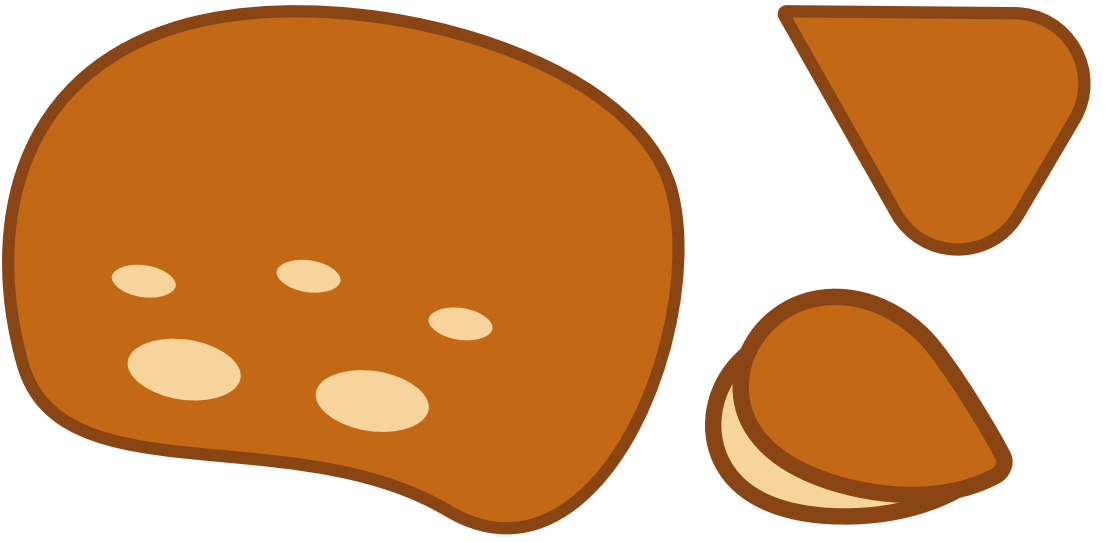
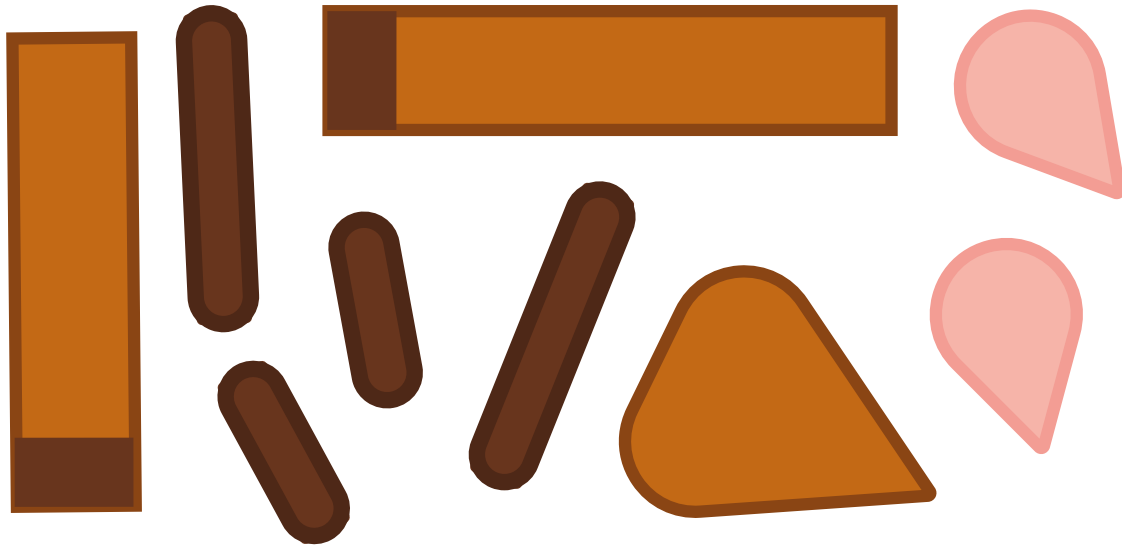

ГДЕ ЧЕЙ ПОДАРОК?

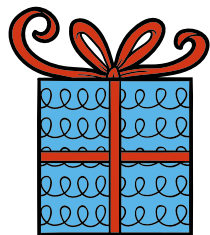
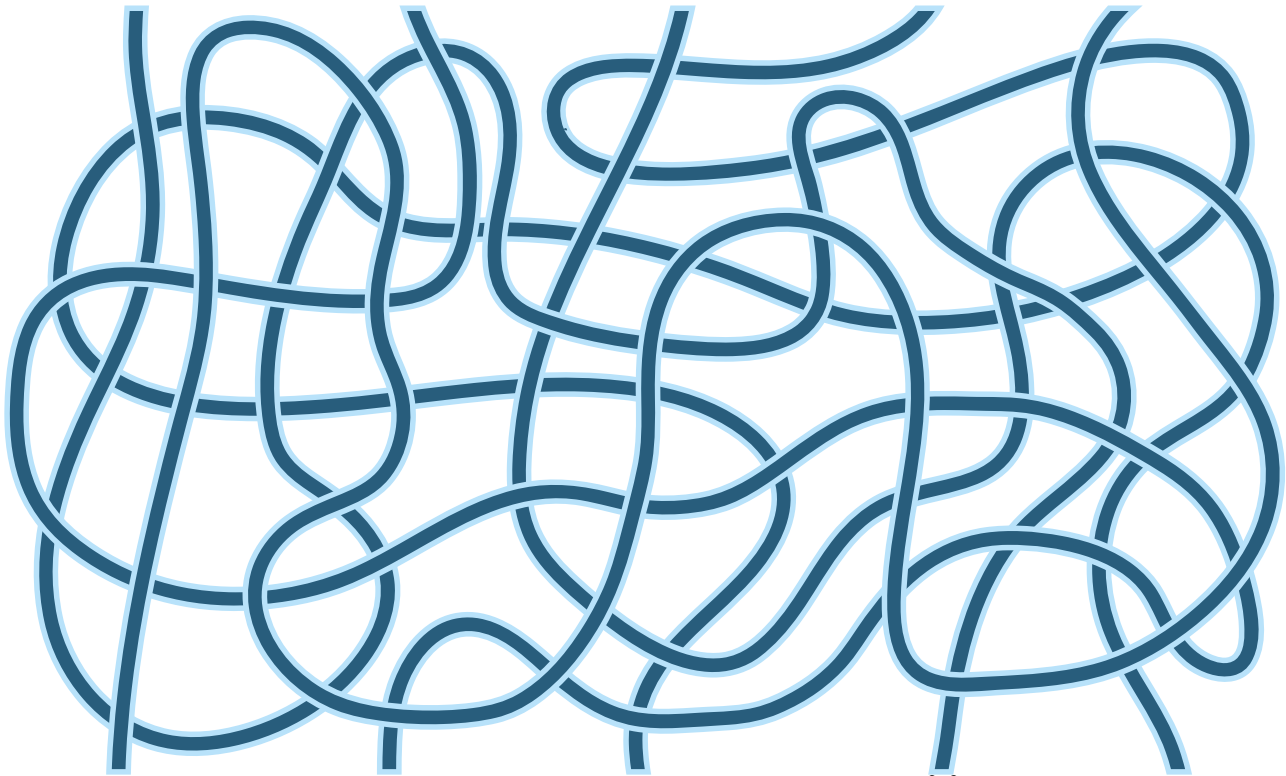

9  
ДЕКАБРЯ



УКРАСЬ ЭТУ ЕЛКУ ПЛАСТИЛИНОВЫМИ ШАРИКАМИ



НАКЛЕЙ НА ВЕТКИ ДЕРЕВА СНЕЖОК ИЗ ВАТЫ

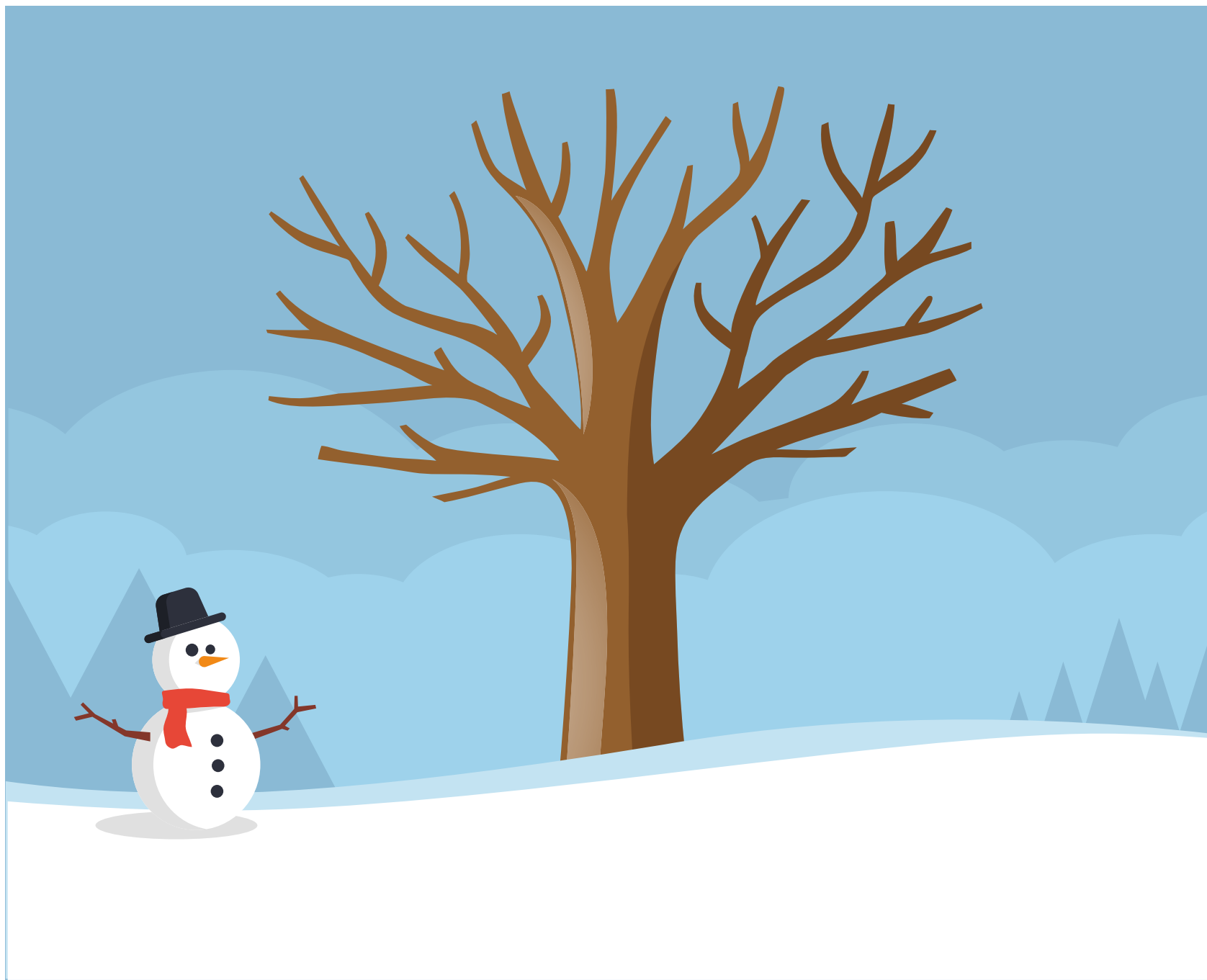

11  
ДЕКАБРЯ



# СОСЧИТАЙ ОБЪЕКТЫ



# СДЕЛАЙ И ПОВЕСЬ НА СТЕНУ ЕЛОЧКУ ИЗ ВЕТОК



13  
ДЕКАБРЯ



ГДЕ ЧЕЙ ДОМ?

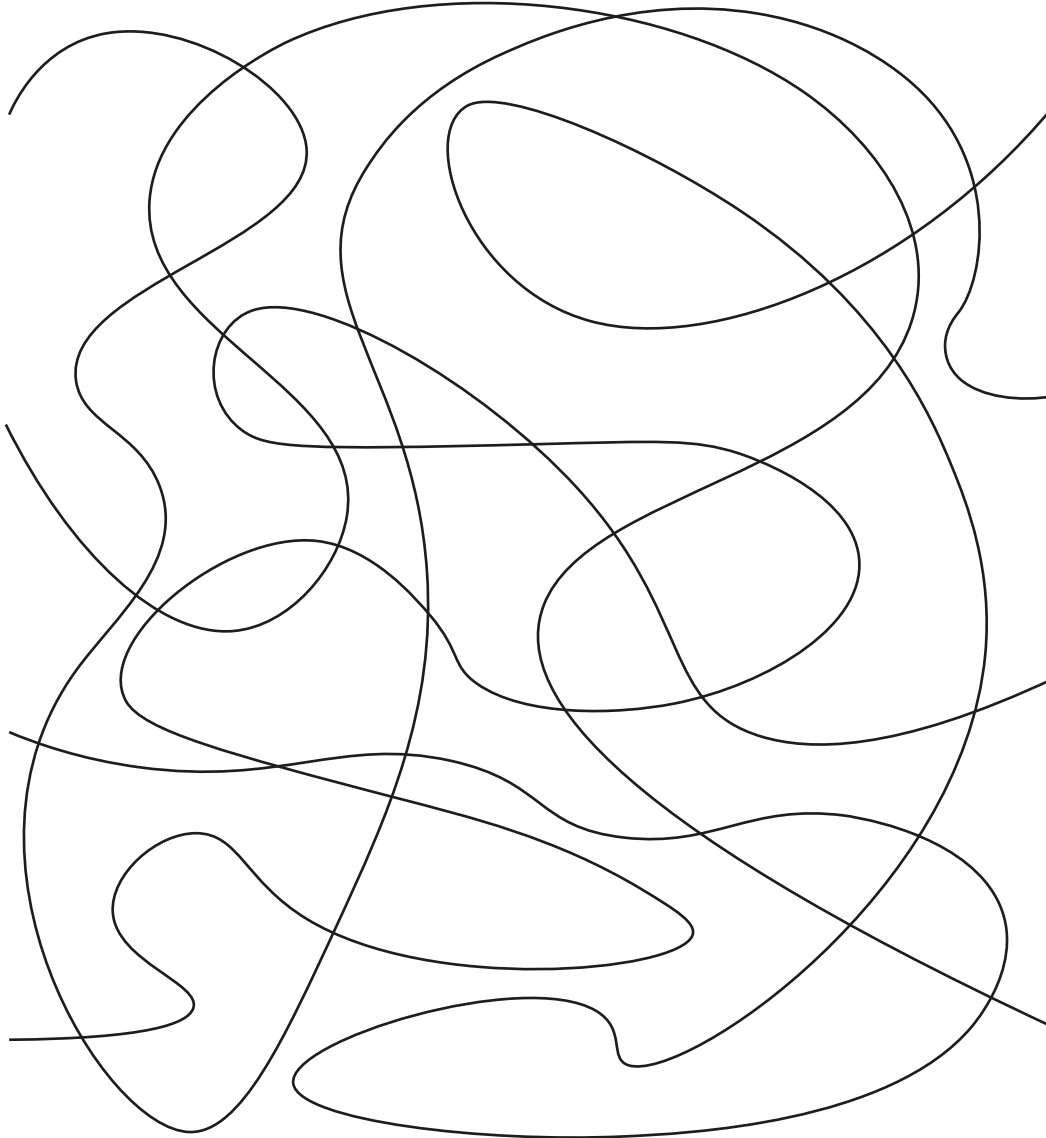

14  
ДЕКАБРЯ



ПЕРЕСЧИТАЙ ВСЕХ САНТА КЛАУСОВ

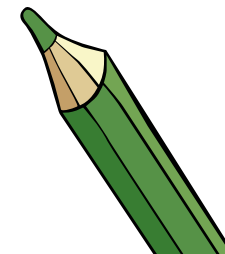

15  
ДЕКАБРЯ





**СОЕДИНИ ПО ТОЧКАМ И РАСКРАСЬ**

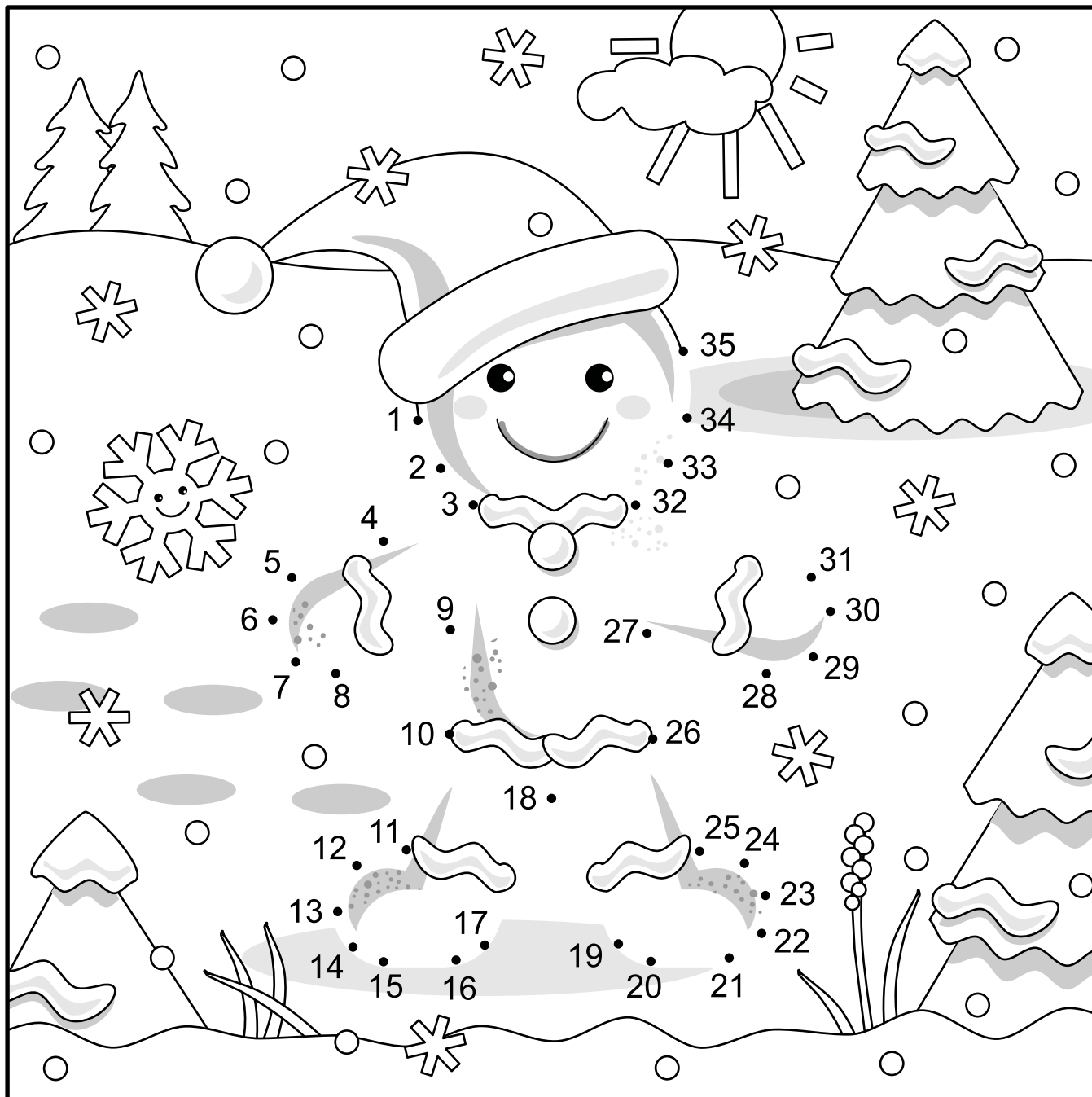

**16**  
**ДЕКАБРЯ**



СМАСТЕРИ МЫШКУ – СИМВОЛ НАСТУПАЮЩЕГО ГОДА

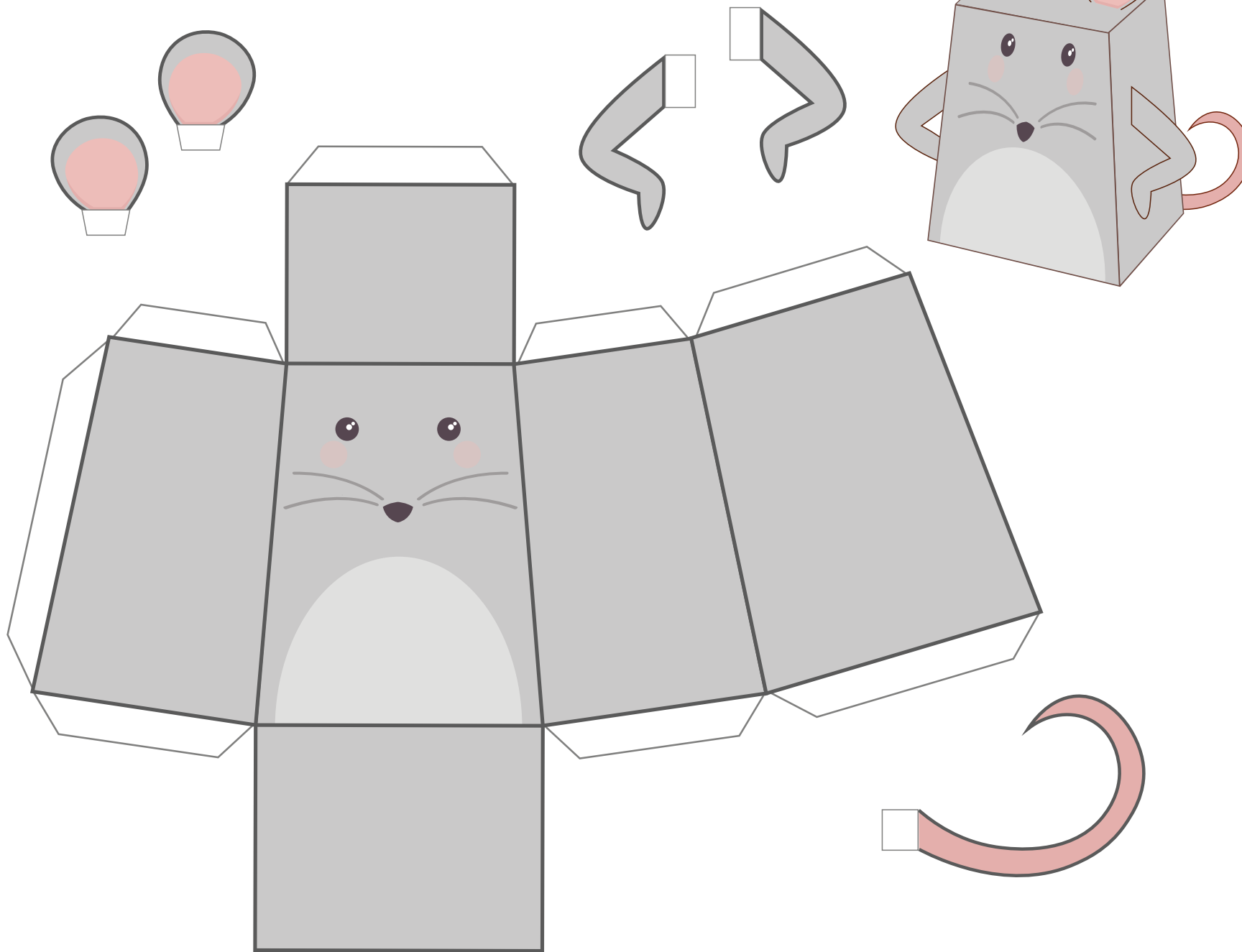

РАСКРАСЬ КАРТИНКУ



18  
ДЕКАБРЯ



ПОМОГИ РЕБЯТАМ НАРЯДИТЬСЯ



19  
ДЕКАБРЯ



УКРАСЬ ПРЯНИЧНЫХ ЧЕЛОВЕЧКОВ ШАРИКАМИ И "КОЛБАСКАМИ" ИЗ ПЛАСТИЛИНА

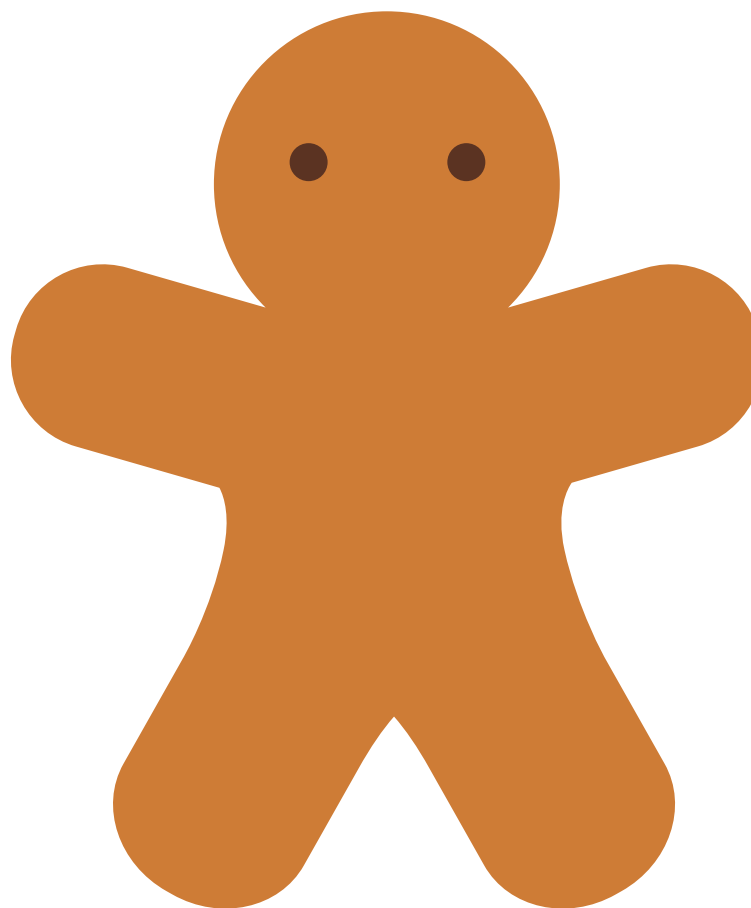
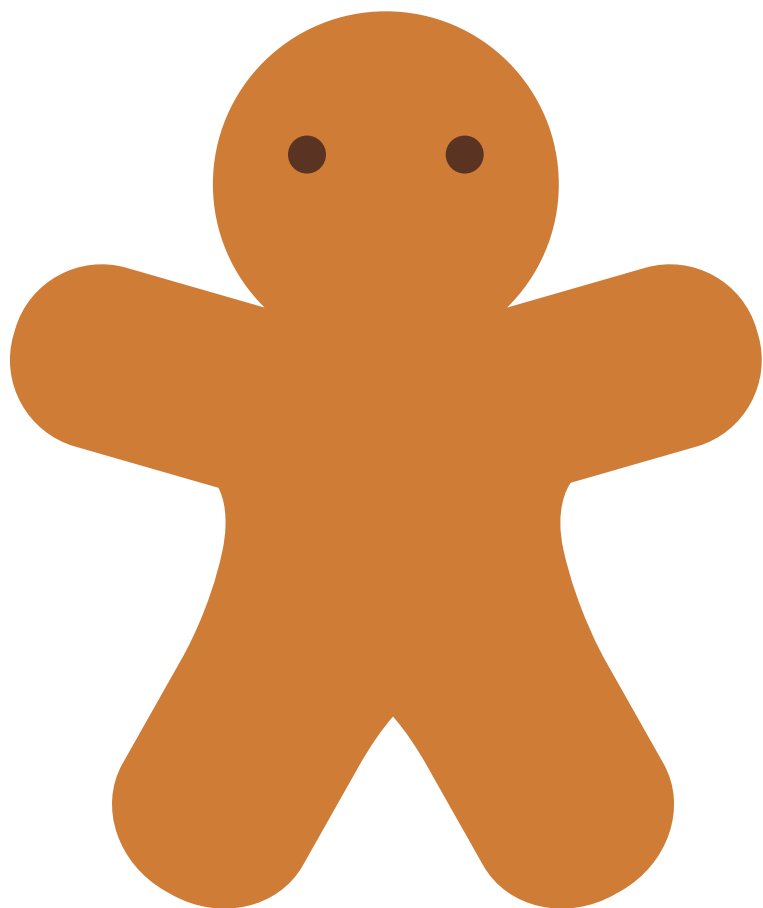

20  
ДЕКАБРЯ



РАЗРЕЖЬ КАРТИНКУ ПО ГОРИЗОНТАЛЬНЫМ ЛИНИЯМ И СОБЕРИ ЕЕ



21  
ДЕКАБРЯ  
\*\*\*



СМОЖЕШЬ ПОВЕСИТЬ ШАРИКИ НА ЕЛКУ?

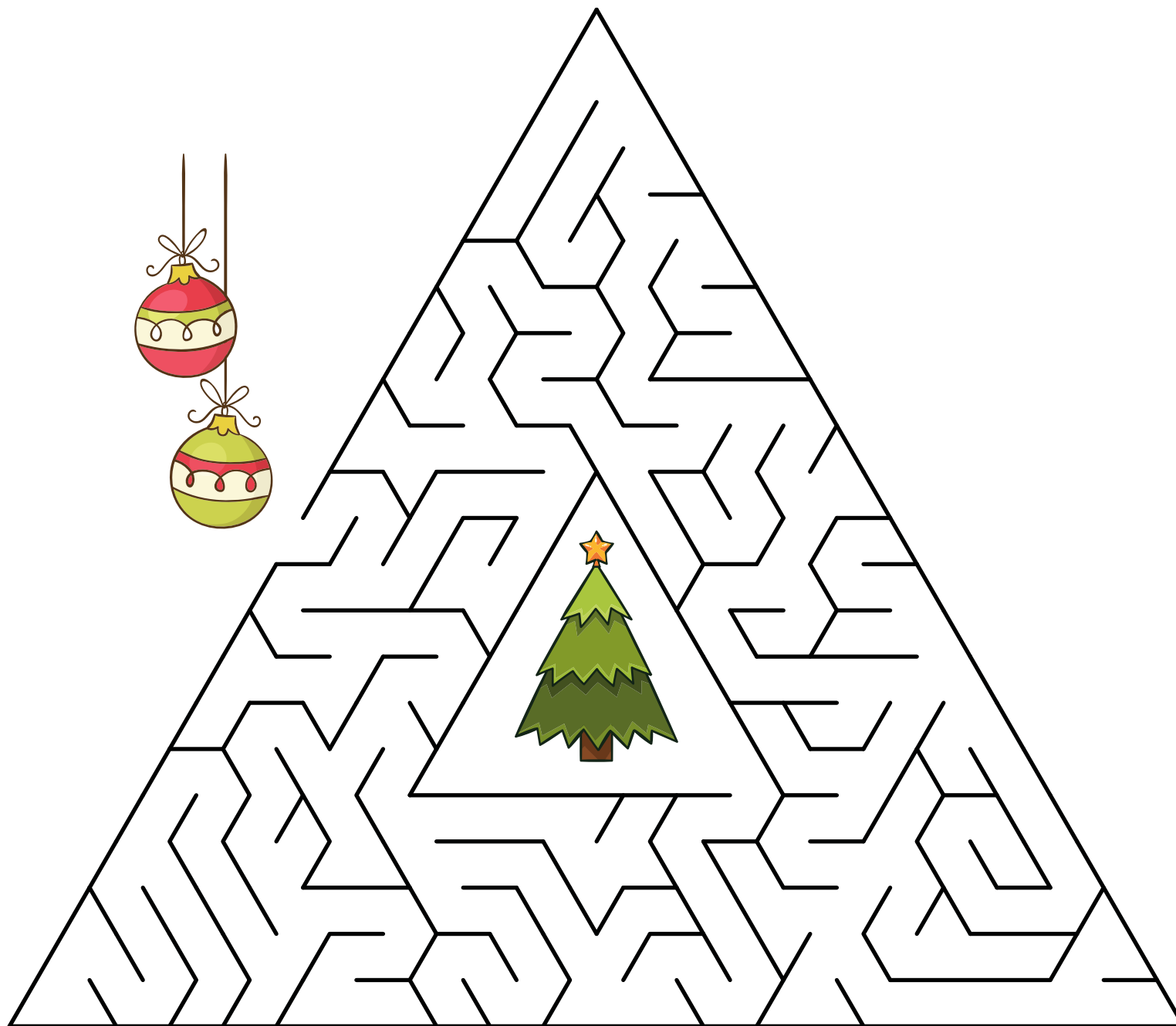

22  
ДЕКАБРЯ



# СДЕЛАЙ ИГРУШКУ ДЛЯ ЁЛКИ



- 1 Вырежи контур
- 2 Сложи и склей
- 3 Вырежи фигурку
- 4 Повесь на ёлку



23  
ДЕКАБРЯ





У ВСЕХ САНТА-КЛАУСОВ ЕСТЬ ДВОЙНИКИ. КРОМЕ ОДНОГО. НАЙДЕШЬ ЕГО?



24  
ДЕКАБРЯ



СКОЛЬКО ЗДЕСЬ ПОДАРКОВ, ЗВЕЗДОЧЕК, ШАРОВ И ЛЕДЕНЦОВ?

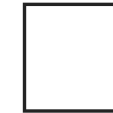
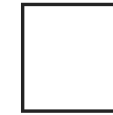

25  
ДЕКАБРЯ



ДОМИК НА ЁЛКУ: ВЫРЕЖИ И СКЛЕЙ

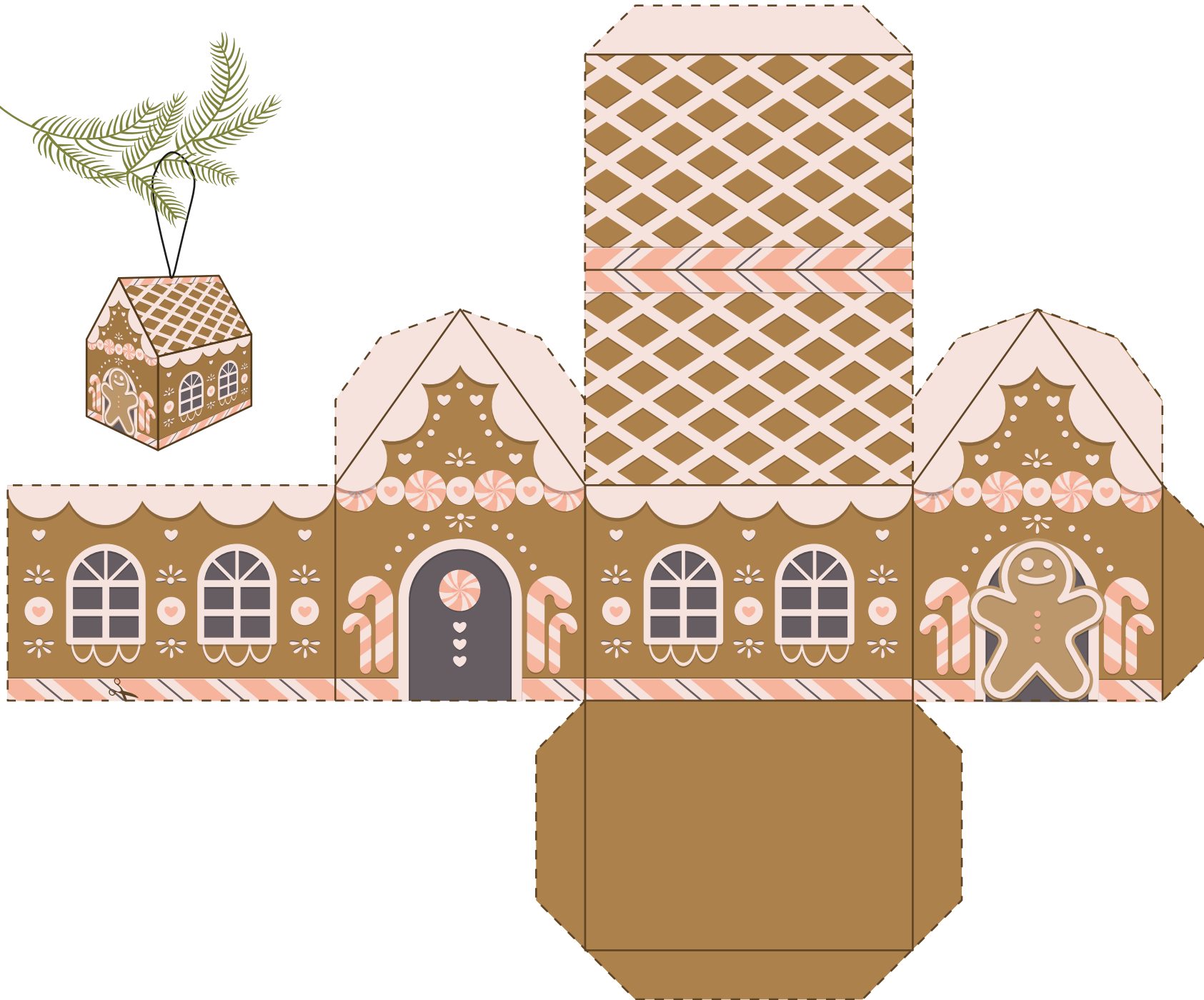

СОЕДИНИ КАЖДОГО САНТУ С ЕГО ТЕНЬЮ

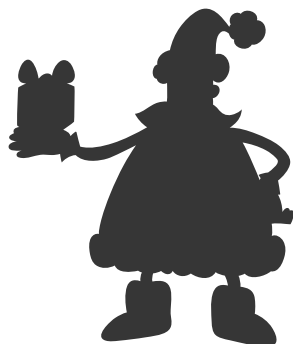
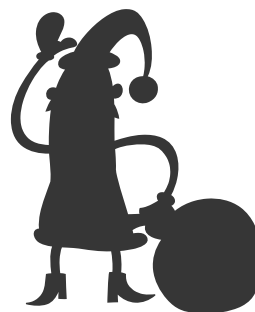

27  
ДЕКАБРЯ



# РАСКРАСЬ ПО НОМЕРАМ

1	2	2	2	1	2	2	2	2	1	2	2	2
2	2	1	2	2	2	1		1	2	1	2	2
2	2	2	1	1	6	6	6	1	1	2	2	1
2	1	1	2	6	6	6	6	6	2	1	1	2
1	5	5	5						5	5	5	1
2	5	4	5	5	5	5	5	5	5	4	5	2
2	5	5	5	5	5	5	5	5	5	5	5	2
1	2	2	5	8	5	5	5	8	5	2	2	2
2	2	1	7	5	4	8	4	5	7	1	2	1
1	2	2	5	5	4	4	4	5	5	2	1	1
2	2	2	5	5	5	5	5	5	5	2	2	2
2	1	3	3	3	3	3	3	3	3	3	1	2
2	2	6	6	6	6	6	6	6	6	6	2	2
2	2	2	2	2	2	2	2	2	2	2	2	2

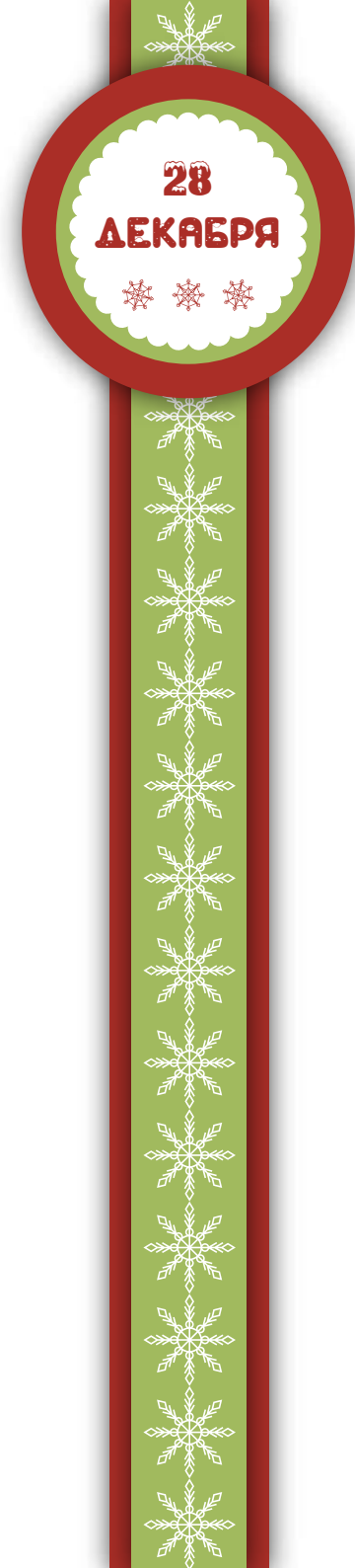
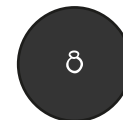
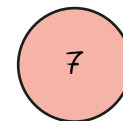
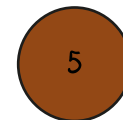
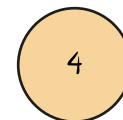
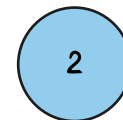
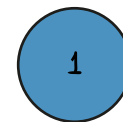

ОБВЕДИ И РАСКРАСЬ НОВОГОДНИЙ ПОДАРОК. КАК ДУМАЕШЬ, ЧТО ТАМ ВНУТРИ?

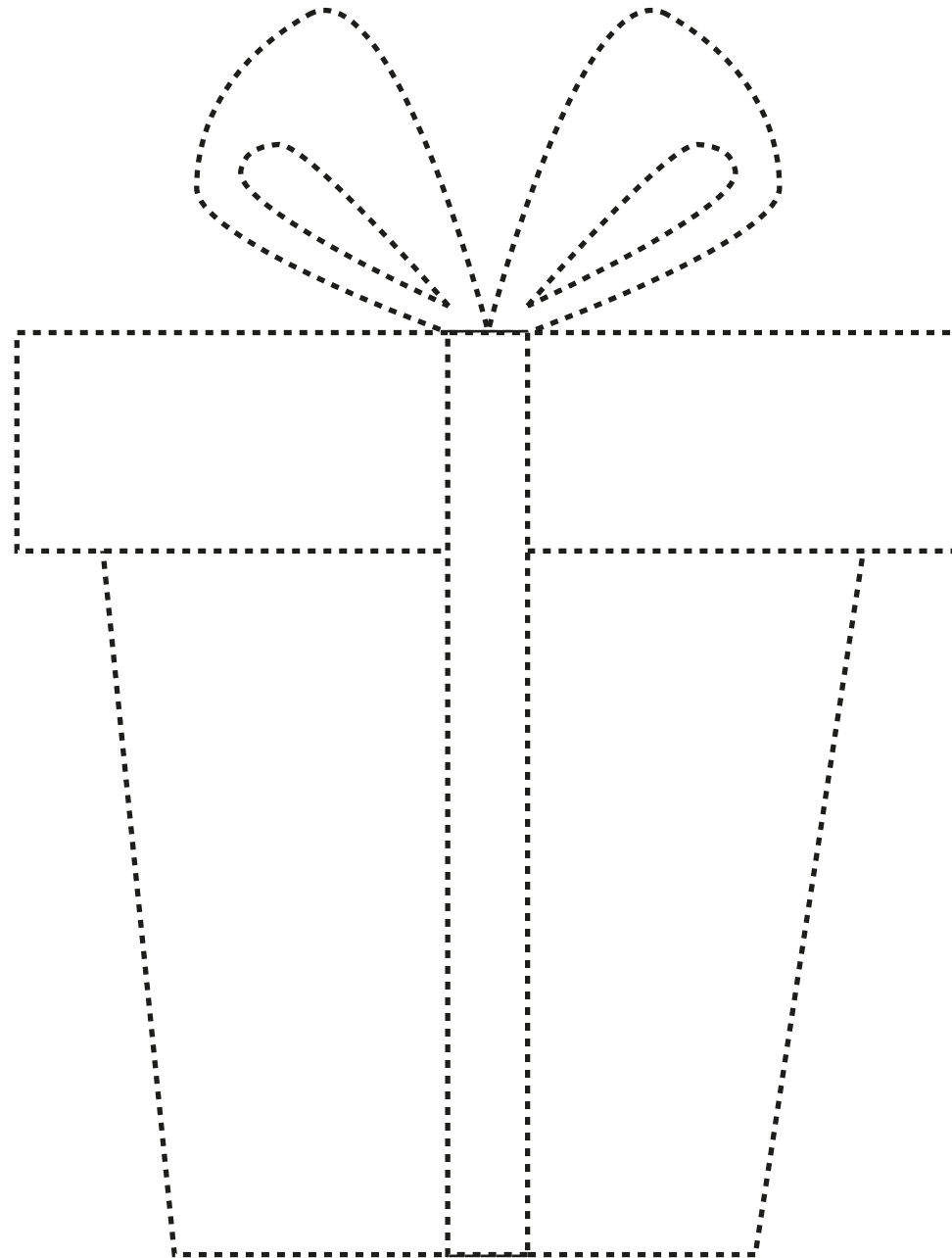

В ЭТУ КОРОБКУ МОЖНО ПОЛОЖИТЬ ПОДАРОЧЕК

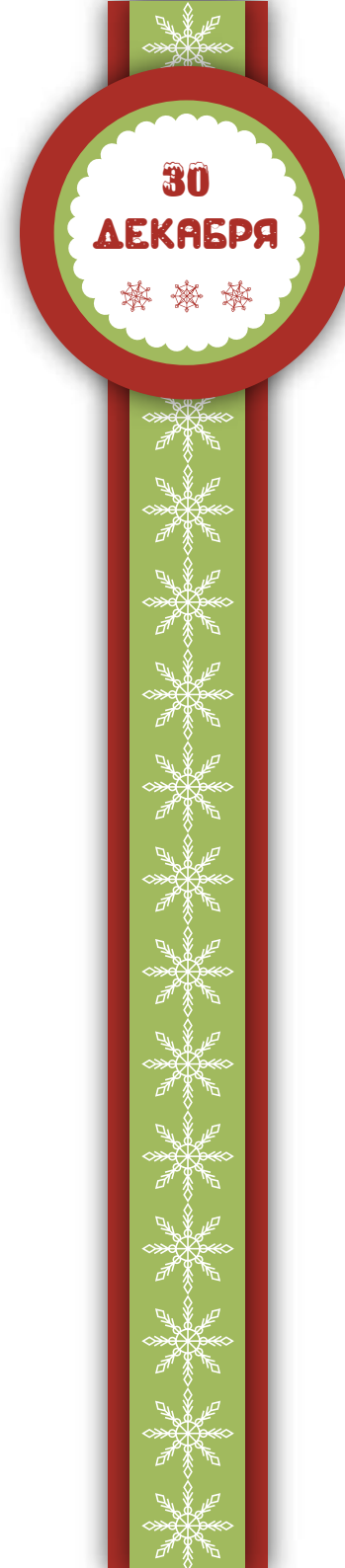
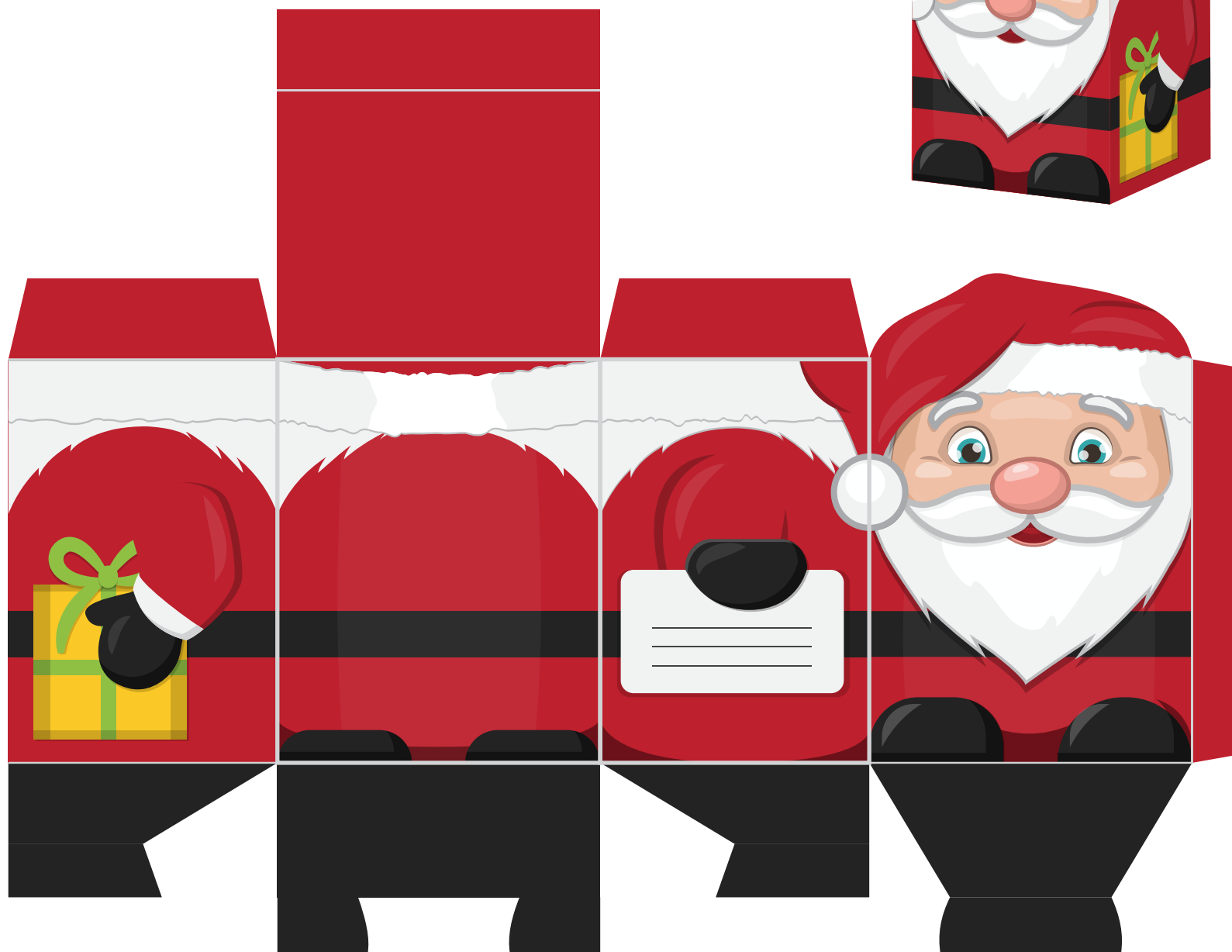

ВОЗЬМИ ИГРАЛЬНЫЙ КУБИК И СЫГРАЙ В ИГРУ. С НОВЫМ ГОДОМ!

